

7.50 inches [19.05 cm]

inches

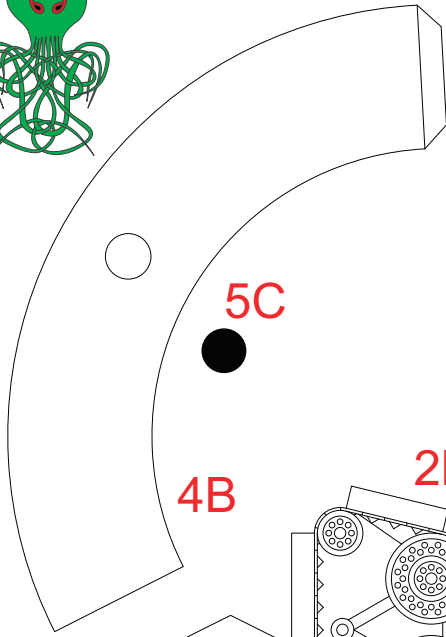
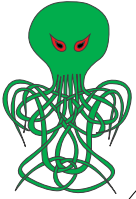

5C

4B

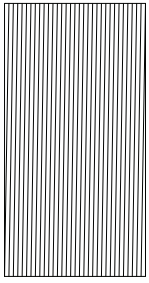

5B

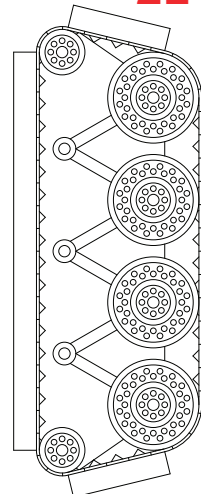
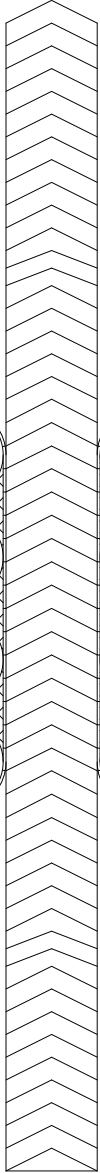

2L

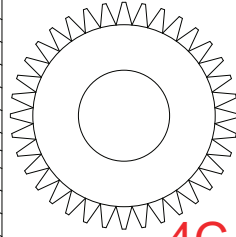

4C

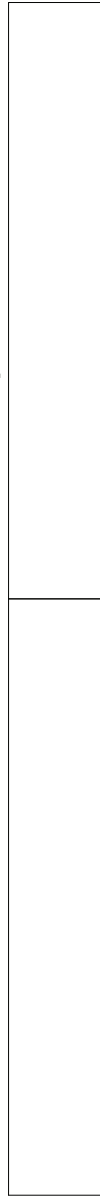
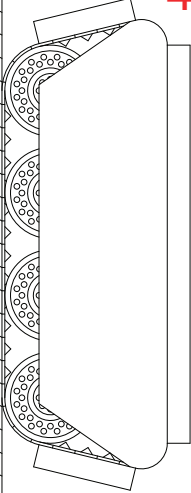

3B

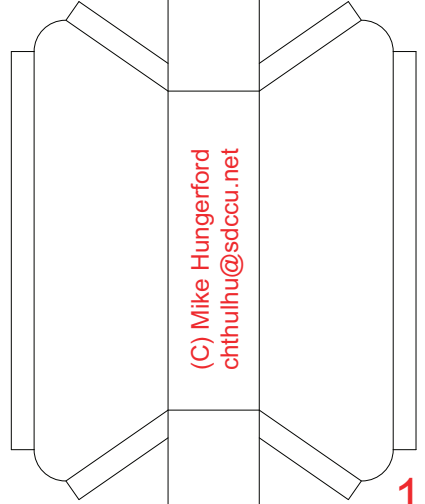

(C) Mike Hungerford
chthulhu@sdccu.net

1

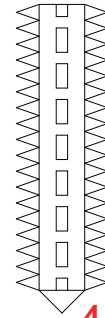

4E



4F



4D

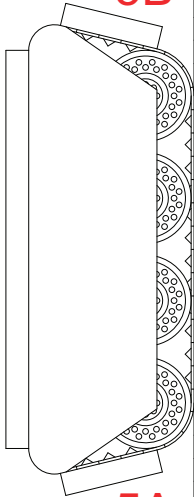

5A

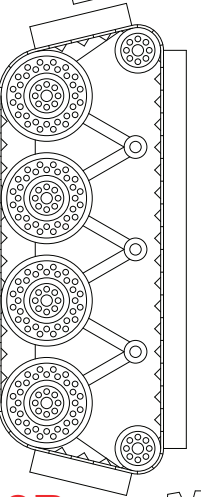

2R

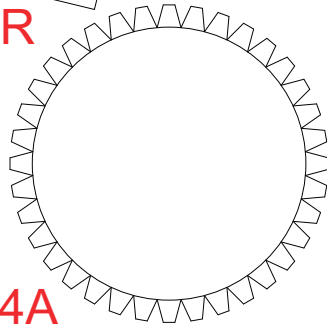

4A

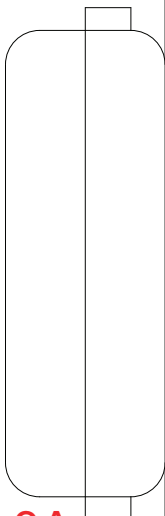

3A

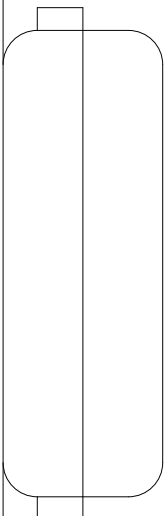
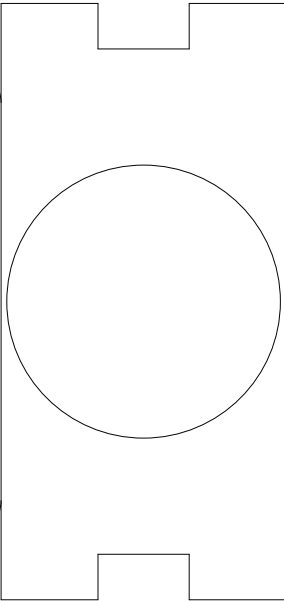

cm

cm

10.00 inches [25.40 cm]